



LAHKIRI & KAMOUCHE

HARDWARE FURNITURE & ACCESSORIES

Ⓜ SARL : LAHKIRI & KAMOUCHE

+97450247663
+213654768042
📞 +393477317071 Ⓜ sarl.lahkirikamouche@gmail.com
+213553317618



CONTENTS

Hinge series

P1-P12

Slide series

P13-P24

Gas support

P29-P32



LAHKIRI & KAMOUCHE
HARDWARE FURNITURE & ACCESSORIES

Hinge Adjustment

RIGHT/LEFT ADJUSTMENT OF DOOR 铰链门的左右调校



一种特别发展的技术办法使门身可左右调校达5毫米，同时可利用铰链臂上的安装锁装置，重新掩盖门身后的夹缝（L初始值为0.7毫米）。

With a specially developed technical solution it is possible to make a right/left door adjustment up to 5mm. Also with the fitting lock device on the hinge arm, the gap behind the door can be covered (original value is 0.7mm).

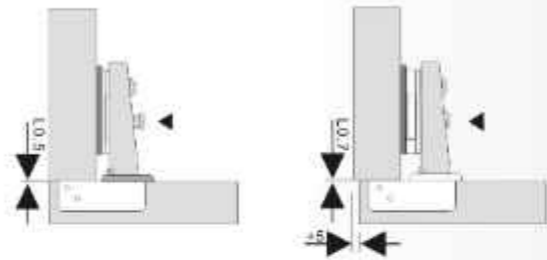

CONVENTIONAL DEPTH ADJUSTMENT 普通式深度调校



扭松铰链座上两枚已紧固的螺栓，铰链座上椭圆形螺孔可使铰链前后移动，可使门身向前移动2.5毫米。调校完毕，应重新紧固螺栓。

By loosening the two fastened screws in the hinge base, you can move the hinge back or forth and so you can move the door forward for 2.5mm. After adjustment, remember to fasten the screws again.

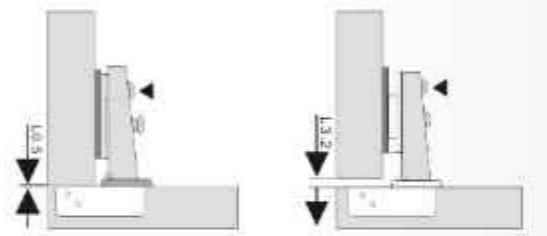

CONVENTIONAL UP/DOWN ADJUSTMENT 传统式上下调校



扭松两枚已紧固的螺栓，可使柜门上下移动上1.5椭圆形螺孔可使铰链座向上、下两方移动。调校完毕，应重新紧固螺栓。

By loosening the two fastened screws in the hinge base, you can move the door up or down for +1.5mm. After adjustment, remember to fasten the screws again.

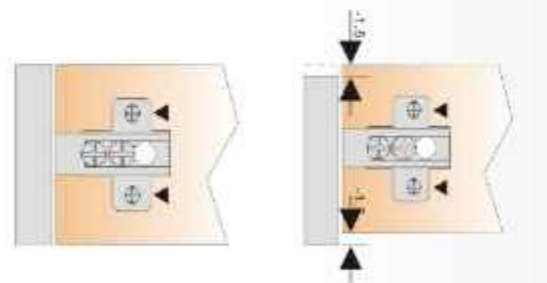

THREE-DIMENSIONAL ADJUSTMENT 三维调节

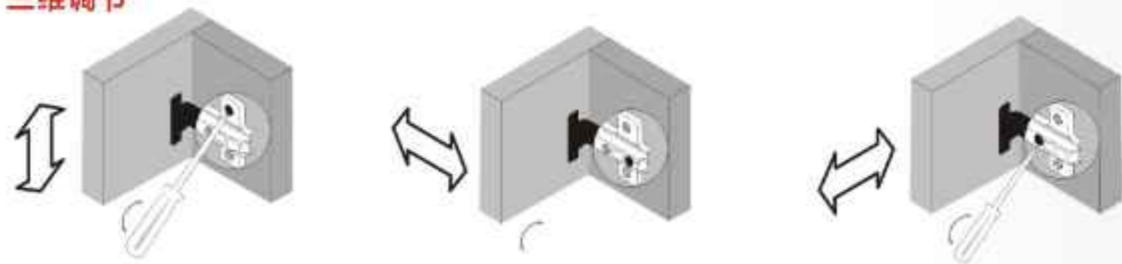

铰链调节参数

CLASSIFICATION OF HINGES 铰链的分类

铰链的弯曲程度一般可以分为以下三种：

- 直弯：**直弯铰链的铰链臂是直的，与门或窗呈90度夹角，开合角度相对较小，适用于一些开启角度较小的门或窗。比如普通木门、铝合金门等。
- 中弯：**中弯铰链的铰链臂呈一定程度的曲线，开合角度比直弯铰链稍大，和门或窗呈120度左右夹角，适用于开启角度较大的门或窗。比如移门、折叠门等。
- 大弯：**大弯铰链的铰链臂弯曲程度最大，和门或窗呈135度角，开合角度相对较大，适用于开启角度较大的门或窗。比如部分淋浴房门或折叠窗。可以在安装位置较为狭窄的环境下更好的适应角度。

The degree of bending of hinges can generally be divided into the following three types:
1. Straight bend: The hinge arm of the straight bend hinge is straight, forming a 90 degree angle with the door or window, and the opening and closing angle is relatively small, suitable for doors or windows with small opening angles. For example, ordinary wooden doors, aluminum alloy doors, etc.
2. Mid bend: The hinge arm of a mid bend hinge forms a certain degree of curve with a slightly larger opening and closing angle than a straight hinge, forming an angle of about 120 degrees with the door or window. It is suitable for opening doors or windows with larger angles, such as sliding doors, folding doors, etc.
3. Big bend: The hinge arm of the big bend hinge has the highest degree of bending, forming a 135 degree angle with the door or window, and the opening and closing angle is relatively large. Suitable for doors or windows with large opening angles, such as some shower doors or folding windows, which can better adapt to narrow installation positions.

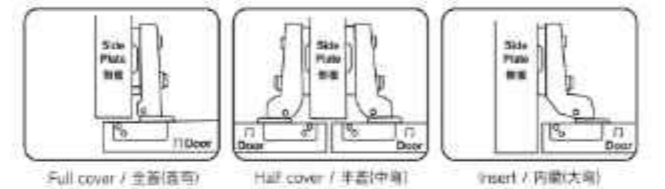

TYPE OF HINGE CUP 铰杯种类

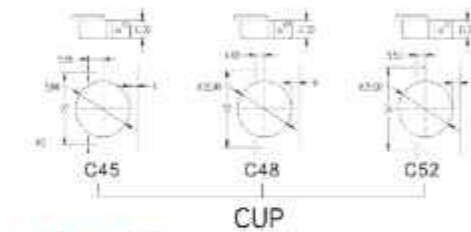

SCREW OF HINGE CUP 铰杯螺丝



HINGE BASE 铰链底座

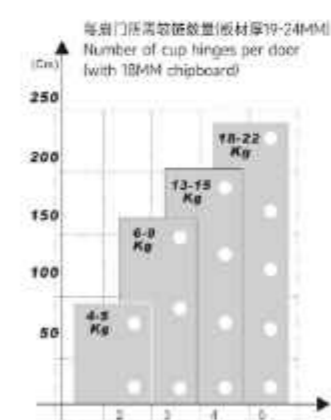
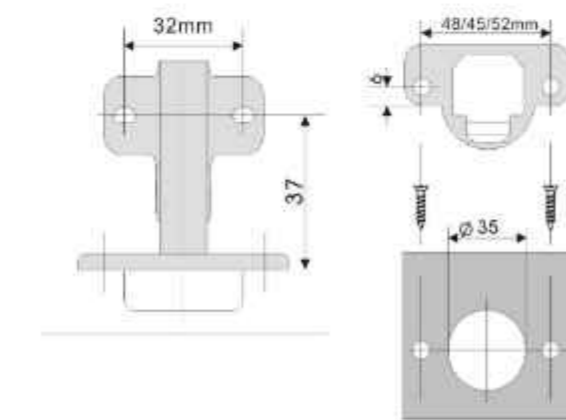

Hinge Series

35mm Cup SS Hydraulic Hinge / 不锈钢可泡水系列

Full cover / 全盖(直弯) Half cover / 半盖(中弯) Insert / 内嵌(大弯) Back / 背面



GC304 SUS 304 Hydraulic Hinge



GC2.0 Full SS 2.0 Hydraulic Hinge



GC1.5 Full SS 1.5 Hydraulic Hinge



GCN863 Half SS Hydraulic Hinge

Material/材质: Stainless steel/不锈钢

Angle of opening/开启角度: 95°-110°

Cup diameter/杯直径: 35mm

Depth/深度: 11.5mm

Hole pitch/孔距: 48mm

Door thickness/门板厚度: 14-20mm

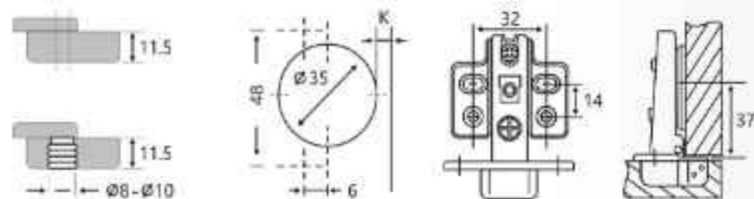

铰链系列

35mm Cup 3D Hydraulic Hinge / 三维调节铰链系列

Full cover / 全盖(直弯) Half cover / 半盖(中弯) Insert / 内嵌(大弯) Back / 背面



GC826 3D04 Iron 3D Hydraulic Nickel hinge



GC826 3D06 Iron 3D Hydraulic Gun black hinge with 6 hole



GCM 3D14 Iron 3D Hydraulic



GC3D04 SS or Iron 3D Hydraulic hinge

Material/材质: Stainless steel/iron

Angle of opening/开启角度: 95°-110°

Cup diameter/杯直径: 35mm

Depth/深度: 11.5mm

Hole pitch/孔距: 48mm

Door thickness/门板厚度: 14-20mm

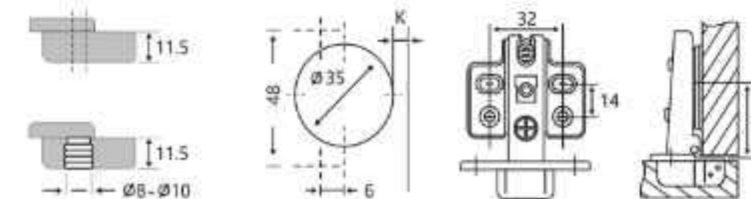

Hinge Series

Aluminum Frame Hinge / 铝框铰链系列

Full cover / 全盖(直弯) Half cover / 半盖(中弯) Insert / 内嵌(大弯) Back / 背面



AF826B Slide-on Aluminum Frame Black Hinge



AF826G Slide-on Aluminum Frame Gold Hinge



AF836N Slide-on Aluminum Frame Nickel Hinge



AF826 3D06 Aluminum Frame 3D Gun Black Hinge with 6 hole

Material/材质: Iron/铁

Angle of opening/开启角度: 95°-110°

Cup diameter/杯直径: 35mm

Depth/深度: 11.5mm

Hole pitch/孔距: 48mm

Door thickness/门板厚度: 14-20mm

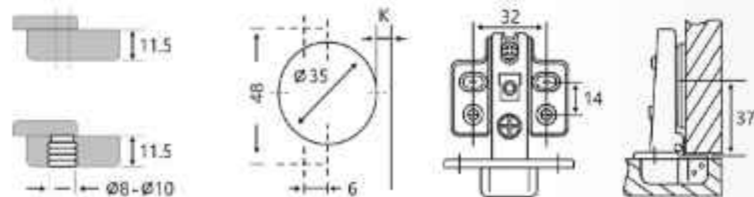

铰链系列

American Short arm Hinge / 美式短臂系列

Full cover / 全盖(直弯) Half cover / 半盖(中弯) Insert / 内嵌(大弯) Back / 背面



SA1H Stainless Steel Short Arm Hinge With Normal screw



SA2 Stainless Steel Short Arm Hinge With 2D screw



SA1H Iron Short Arm Hinge With Normal screw



SA2 Iron Short Arm Hinge With 2D screw

Material/材质: Stainless steel / Iron

Angle of opening/开启角度: 95°-110°

Cup diameter/杯直径: 35mm

Depth/深度: 11.5mm

Hole pitch/孔距: 48mm

Door thickness/门板厚度: 14-20mm

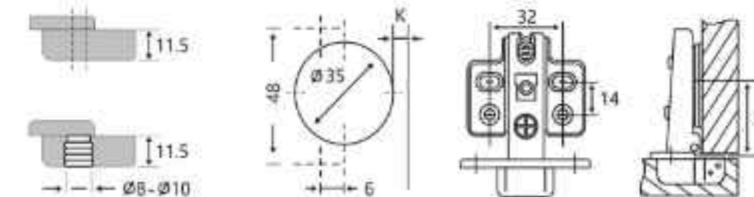

Hinge Series

35mm Cup Hinge With Hook / 35杯铰链带钩系列

Full cover / 全盖(直弯) Half cover / 半盖(中弯) Insert / 内嵌(大弯) Back / 背弯



AF261 Iron Normal Hinge With Hook



AF6264 Iron Hydraulic Hinge With Hook



AF3D Iron Hydraulic 3D Hinge With Hook



AFSS SS Hydraulic Hinge With Hook

Material/材质: Stainless steel / Iron

Angle of opening/开启角度: 95°-110°

Cup diameter/杯直径: 35mm

Depth/深度: 11.5mm

Hole pitch/孔距: 48mm

Door thickness/门板厚度: 14-20mm

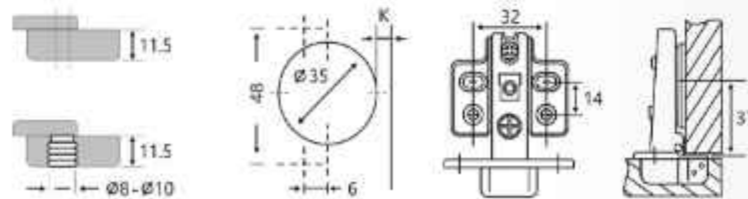

铰链系列

Special Angle hinge / 特殊角度铰链



165°hinge / 165°铰链



135°hinge / 135°铰链

90°hinge / 90°铰链

45°hinge / 45°铰链



30°hinge / 30°铰链

-30°hinge / -30°铰链

-45°hinge / -45°铰链



45° 3Dhinge / 45° 3D铰链

90° 3Dhinge / 90° 3D铰链

165° 3Dhinge / 165° 3D铰链

Material/材质: Stainless steel/不锈钢

Angle of opening/开启角度: 95°-110°

Cup diameter/杯直径: 35mm

Depth/深度: 11.5mm

Hole pitch/孔距: 48mm

Door thickness/门板厚度: 14-20mm

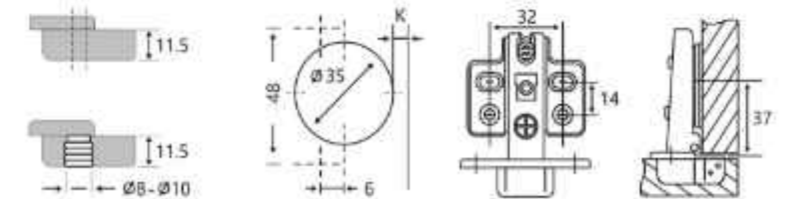

Hinge Series

Special angle aluminum frame hinge / 特殊角度铝框铰链



Expand / 展开 Close / 合起 Back / 背面
165°aluminum frame hinge / 165°铝框铰链



135°hinge / 135°铰链 90°hinge / 90°铰链 45°hinge / 45°铰链



30°hinge / 30°铰链 -30°hinge / -30°铰链 -45°hinge / -45°铰链



3-inch regular model / 3寸普通款 4-inch regular model / 4寸普通款 4-inch hydraulic version / 4寸液压款
Frog Hinge / 青蛙铰链

铰链系列

35mm Cup Normal Iron hinge / 常规铁铰链

Full cover / 全盖(直弯) Half cover / 半盖(中弯) Insert / 内嵌(大弯) Back / 背面



F261 Slide-on Iron Hydraulic hinge



F263 Slide-on Iron Hydraulic hinge



261 Slide-on Iron Normal hinge



A8 Slide-on Iron Normal hinge

Material/材质: Iron/铁
 Angle of opening/开启角度: 95°-110°
 Cup diameter/杯直径: 35mm
 Depth/深度: 11.5mm
 Hole pitch/孔距: 48mm
 Door thickness/门板厚度: 14-20mm

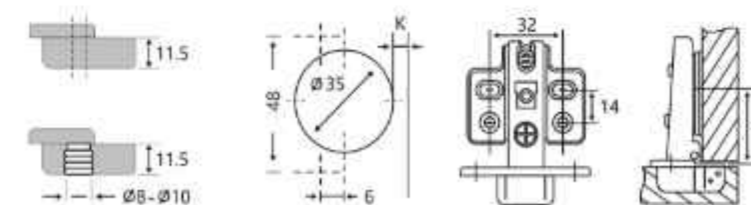

Hinge Series

26mm cup normal hinge / 26杯普通铰链

Full cover / 全盖(直弯) Half cover / 半盖(中弯) Insert / 内嵌(大弯) Back / 背面



2602 Small Iron Normal hinge



2604 Small Iron Normal hinge



26SA Small Iron Short arm Hinge



26G Small Iron Hydraulic/Normal Glass Door Hinge

Material/材质: Iron/铁

Angle of opening/开启角度: 95°-110°

Cup diameter/杯直径: 35mm

Depth/深度: 11.5mm

Hole pitch/孔距: 48mm

Door thickness/门板厚度: 14-20mm

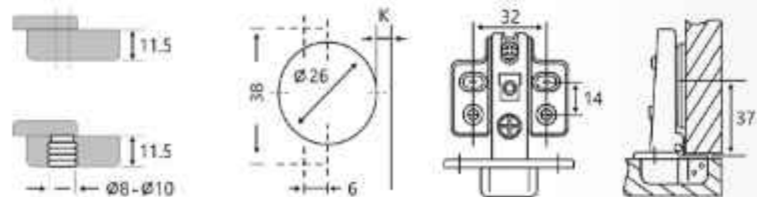

铰链系列

40mm Cup Hydraulic Hinge / 40杯液压铰链系列

Full cover / 全盖(直弯) Half cover / 半盖(中弯) Insert / 内嵌(大弯) Back / 背面



GC403D Iron 3D Hydraulic Hinge



GC404 Iron Hydraulic Hinge



GC403 Iron Hydraulic Hinge



GC401 Slide-on Iron Hydraulic Hinge

Material/材质: Stainless steel/Iron

Angle of opening/开启角度: 95°-110°

Cup diameter/杯直径: 35mm

Depth/深度: 11.5mm

Hole pitch/孔距: 48mm

Door thickness/门板厚度: 14-20mm

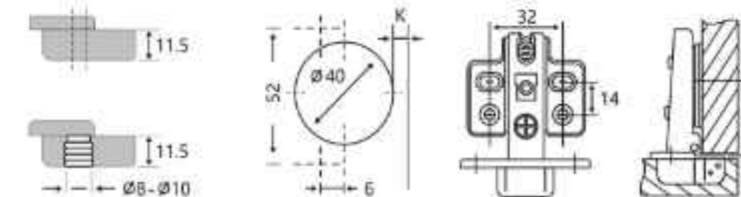

Slide Series

35mm Iron Ball Bearing Slide / 35mm宽铁走珠滑轨

Material/材质: Cold Rolled Steel 冷轧钢
Width/宽度: 35mm
Length/长度: 8inch-18inch (190mm-450mm)
Capacity/承重: 20kg

Cycle/开合: 50000times 5万次
Salt Spray Test/盐雾试验: 48H
Finish/表面处理: black 镀黑 / white 镀白 / printing 印花
Installation/安装方法: side mount 侧面安装

Thickness Range/材料厚度:
① 0.5-0.8mm
② 0.5-0.8mm
③ 0.5-0.8mm

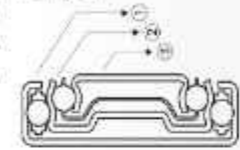

■ black 镀黑 ■ white 镀白 ■ printing 印花

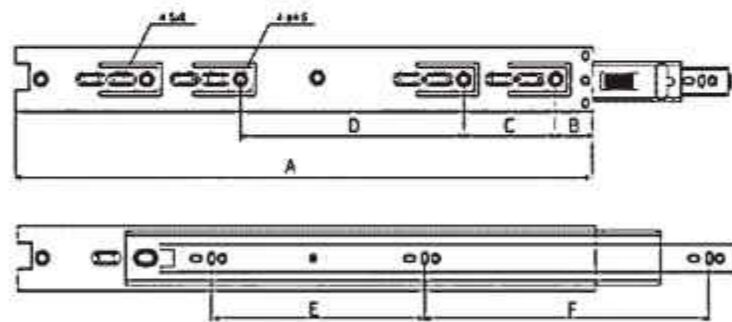

单位: mm

SIZE	A	B	C	D	E	F	G	H
8寸 8Inch	190	35	96			128		
10寸 10Inch	250	35	64	96	96	64		
12寸 12Inch	300	35	64	64	128	96		
14寸 14Inch	350	35	64	96	128	128		
16寸 16Inch	400	35	64	160	160	160		
18寸 18Inch	450	35	64	192	192	160		

滑轨系列

40mm Iron Ball Bearing Slide / 40mm宽铁走珠滑轨

Material/材质: Cold Rolled Steel 冷轧钢
Width/宽度: 40mm
Length/长度: 8inch-18inch (190mm-450mm)
Capacity/承重: 20kg

Cycle/开合: 50000times 5万次
Salt Spray Test/盐雾试验: 48H
Finish/表面处理: black 镀黑 / white 镀白
Installation/安装方法: side mount 侧面安装

Thickness Range/材料厚度:
① 0.5-0.8mm
② 0.5-0.8mm
③ 0.5-0.8mm

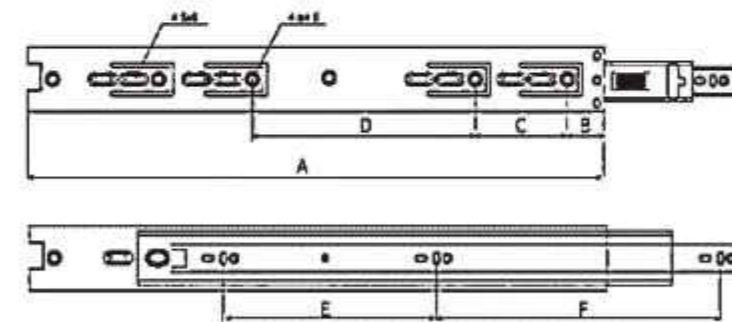
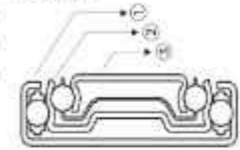

单位: mm

SIZE	A	B	C	D	E	F	G	H
8寸 8Inch	190	35	96			128		
10寸 10Inch	250	35	64	96	96	64		
12寸 12Inch	300	35	64	64	128	96		
14寸 14Inch	350	35	64	96	128	128		
16寸 16Inch	400	35	64	160	160	160		
18寸 18Inch	450	35	64	192	192	160		

Slide Series

45mm Iron Ball Bearing Slide / 45mm宽铁走珠滑轨

Material/材质: Cold rolled steel 冷轧钢
Width/宽度: 45mm
Length/长度: 8inch-24inch (190mm-600mm)
Capacity/承重: 30-45kg

Cycle/开合: 50000times 5万次
Salt Spray Test/盐雾试验: 48H
Finish/表面处理: black 镀黑 / white 镀白
Installation/安装方法: side mount 侧面安装

Thickness Range/材料厚度:
① 0.7-0.9mm
② 0.7-0.9mm
③ 0.7-0.9mm

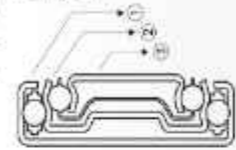

高级钢珠
High Quality Steel Ball



耐高温/低温塑料
High Temperature/Low Temperature
Resistant Plastic

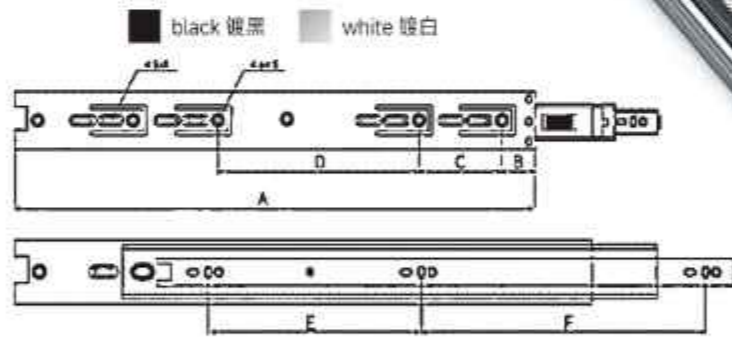

单位: mm

SIZE	A	B	C	D	E	F	G	H
8寸 8Inch	190	35	96			128		
10寸 10Inch	250	35	64	96	96	96		
12寸 12Inch	300	35	64	128	128	96		
14寸 14Inch	350	35	64	96	128	128		
16寸 16Inch	400	35	64	160	192	128		
18寸 18Inch	450	35	64	96	192	160		
20寸 20Inch	500	35	64	128	224	192		
22寸 22Inch	550	35	64	160	224	224		
24寸 24Inch	600	35	64	160	256	256		

滑轨系列

45mm Iron Soft Close Slide / 45mm宽缓冲滑轨

Material/材质: Cold rolled steel 冷轧钢
Width/宽度: 45mm
Length/长度: 8inch-24inch (190mm-600mm)
Capacity/承重: 30-45kg

Cycle/开合: 50000times 5万次
Salt Spray Test/盐雾试验: 48H
Finish/表面处理: black 镀黑 / white 镀白
Installation/安装方法: side mount 侧面安装

Thickness Range/材料厚度:
① 0.7-0.9mm
② 0.7-0.9mm
③ 0.7-0.9mm

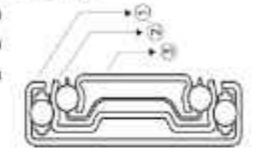

高级钢珠
High Quality Steel Ball



阻尼缓冲装置
Damping Soft Bearing Device

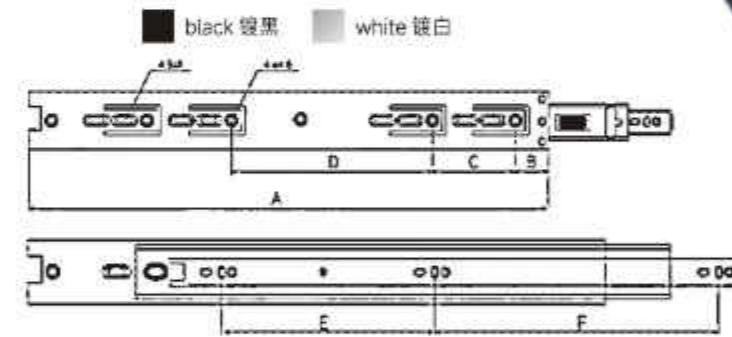

单位: mm

SIZE	A	B	C	D	E	F	G	H
8寸 8Inch	190	35	96			128		
10寸 10Inch	250	35	64	96	96	96		
12寸 12Inch	300	35	64	128	128	96		
14寸 14Inch	350	35	64	96	128	128		
16寸 16Inch	400	35	64	160	192	128		
18寸 18Inch	450	35	64	96	192	160		
20寸 20Inch	500	35	64	128	224	192		
22寸 22Inch	550	35	64	160	224	224		
24寸 24Inch	600	35	64	160	256	256		

Slide Series

Stainless Steel Ball Bearing Slide / 不锈钢 普通滑轨

Material/材质: Stainless steel 不锈钢
 Width/宽度: 45mm
 Length/长度: 10inch-24inch(250mm-600mm)
 Capacity/承重: 20-45kg

Cycle/开合: 50000times 5万次
 Salt Spray Test/盐雾试验: 48H

Thickness Range/材料厚度:
 ① 0.9-1.0mm
 ② 0.9-1.0mm
 ③ 0.9-1.0mm

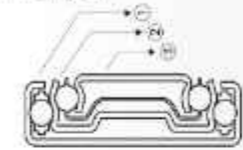

高级钢球
High Quality Steel Ball



阻尼缓冲装置
Damping Soft Closing Device

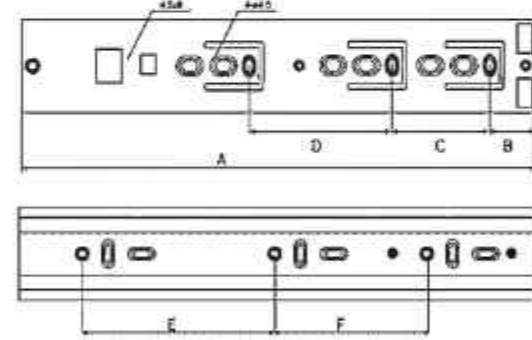
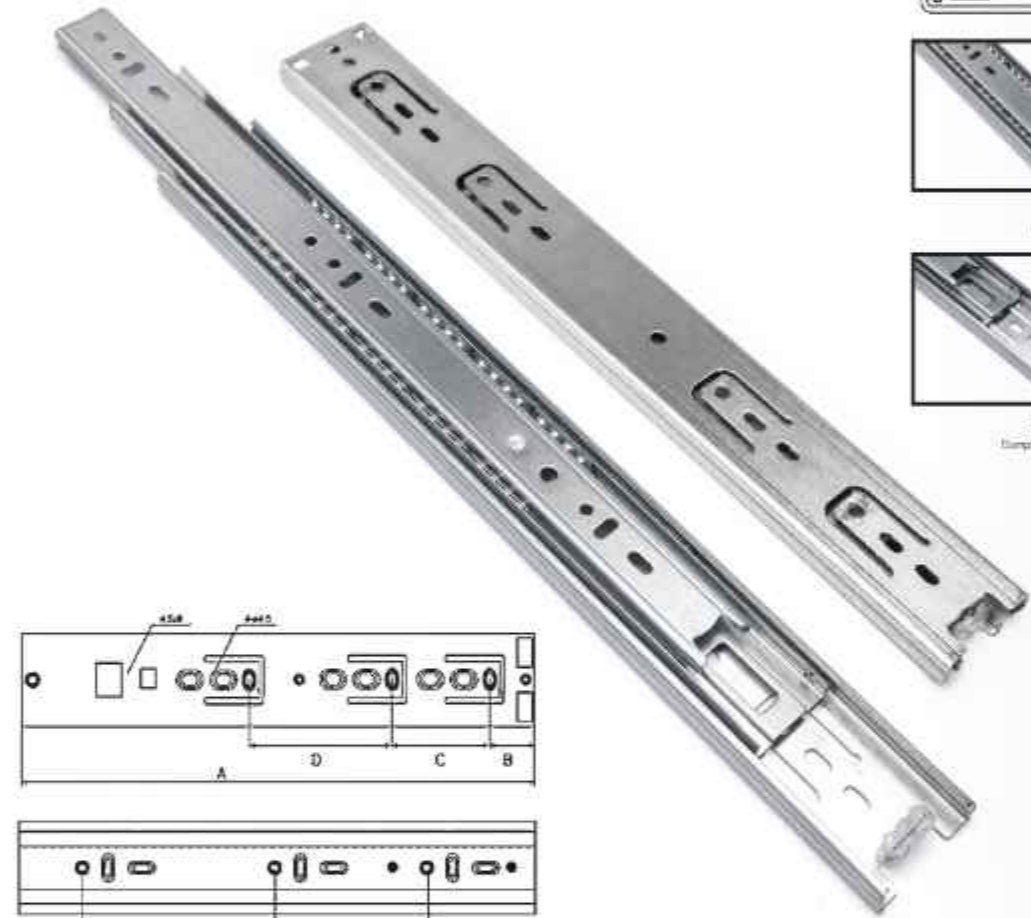

单位: mm

SIZE	A	B	C	D	E	F	G	H
8寸 8Inch	200	35	96			128		
10寸 10Inch	250	35	64	96	96	64		
12寸 12Inch	300	35	64	128	128	96		
14寸 14Inch	350	35	64	128	128	128		
16寸 16Inch	400	35	64	160	192	128		
18寸 18Inch	450	35	64	224	192	160		
20寸 20Inch	500	35	64	128	224	192		
22寸 22Inch	550	35	64	160	224	224		
24寸 24Inch	600	35	64	192	256	256		
26寸 26Inch	650	35	64	224	256	288		

滑轨系列

45mm Stainless Steel Soft Close Slide / 45mm 不锈钢 缓冲滑轨

Material/材质: Stainless steel 不锈钢
 Width/宽度: 45mm
 Length/长度: 10inch-24inch(250mm-600mm)
 Capacity/承重: 20-45kg

Cycle/开合: 50000times 5万次
 Salt Spray Test/盐雾试验: 48H

Thickness Range/材料厚度:
 ① 0.9-1.0mm
 ② 0.9-1.0mm
 ③ 0.9-1.0mm

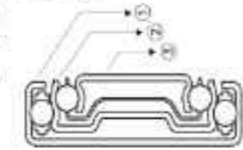

高级钢球
High Quality Steel Ball



阻尼缓冲装置
Damping Soft Closing Device

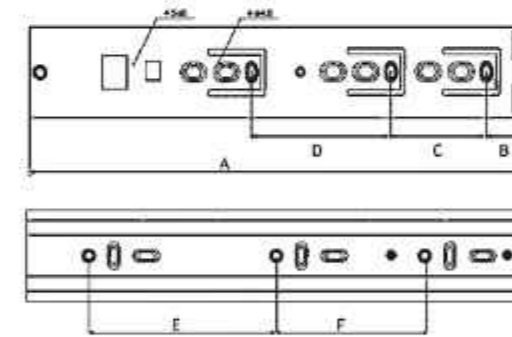

单位: mm

SIZE	A	B	C	D	E	F	G	H
8寸 8Inch	200	35	96			128		
10寸 10Inch	250	35	64	96	96	64		
12寸 12Inch	300	35	64	128	128	96		
14寸 14Inch	350	35	64	128	128	128		
16寸 16Inch	400	35	64	160	192	128		
18寸 18Inch	450	35	64	224	192	160		
20寸 20Inch	500	35	64	128	224	192		
22寸 22Inch	550	35	64	160	224	224		
24寸 24Inch	600	35	64	192	256	256		
26寸 26Inch	650	35	64	224	256	288		

Slide Series

2-Fold Soft Close Undermount Slide / 二节缓冲隐藏轨

Material/材质: Cold rolled steel 冷轧钢板
 Length/长度: 10inch-24inch(250mm-600mm)
 Capacity/承重: 35kg
 Installation/安装方式: Under mount 底部安装

Cycle/开合: 50000times 5万次
 Salt Spray Test/盐雾试验: 48H
 Finish/表面处理: Zinc plating 镀锌



精密阻尼器
Precision damping pipe



镀锌板, 嵌滑轨
Galvanized common rest

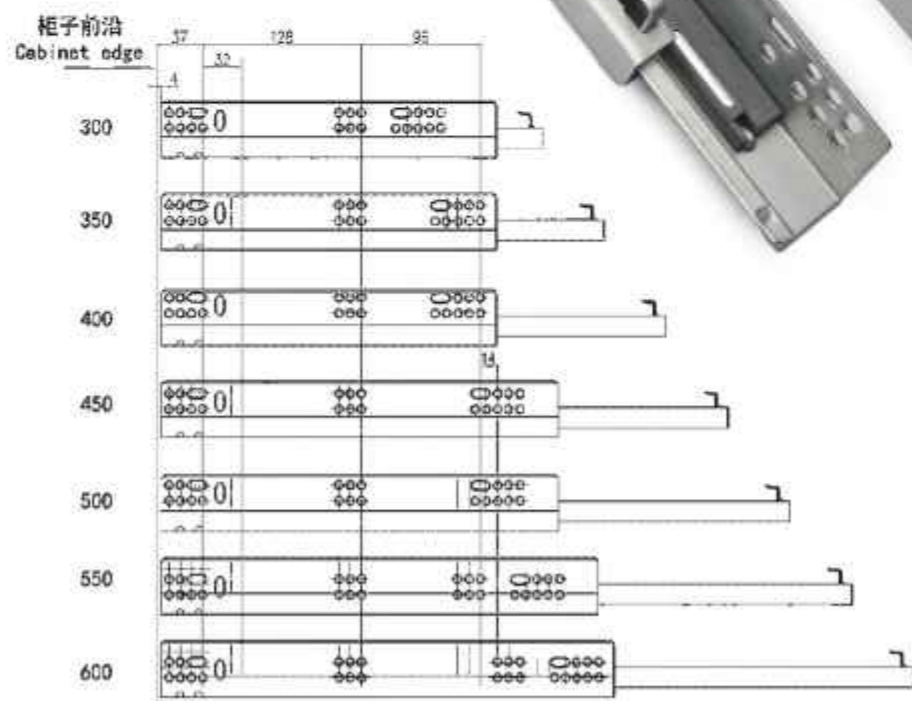

滑轨系列

Bidirectional ball slide / 双向走珠滑轨

Material/材质: Cold rolled steel 冷轧钢
 Length/长度: 8inch-24inch(182mm-438mm)
 Capacity/承重: 15kg
 Installation/安装方式: Under mount 底部安装

Cycle/开合: 50000times 5万次
 Salt Spray Test/盐雾试验: 48H
 Finish/表面处理: Blue zinc/Black 蓝锌/电泳黑处理

Thickness Range/材料厚度:
 ① 0.8mm-1.0mm
 ② 0.8mm-1.0mm



消声钢珠
Muffled ball



采用优良材料
Using high quality materials

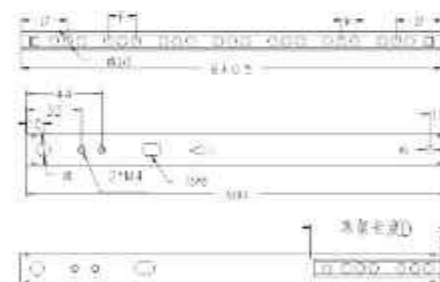
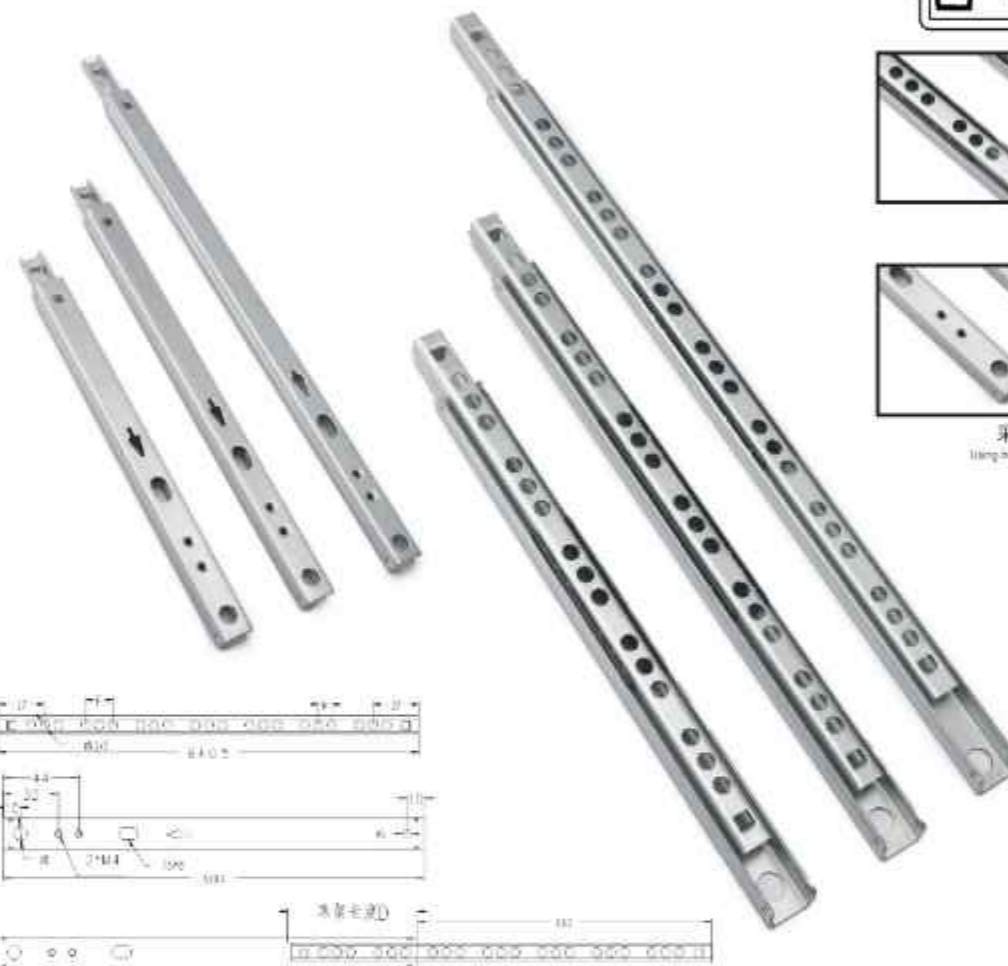

单位: mm

SIZE	A	B	C	D	E	F	G	H
8寸 8Inch	182	182	127	54	32/44	5		80/90
10寸 10Inch	214	214	139	74	32/44	6		80/90
12寸 12Inch	246	246	171	74	32/44	7		80/90
14寸 14Inch	278	278	203	74	32/44	8		80/90
16寸 16Inch	310	310	213	96	32/44	9		80/90
18寸 18Inch	342	342	245	96	32/44	10		80/90
20寸 20Inch	374	374	277	96	32/44	11		80/90
22寸 22Inch	406	406	309	96	32/44	12		80/90
24寸 24Inch	438	438	341	96	32/44	13		80/90

Slide Series

53mm/76mm Heavy duty Soft Close Slide / 53mm宽/76mm宽重型缓冲滑轨

Material/材质: Cold rolled steel 冷轧钢板
 Width/宽度: 53mm/76mm
 Thickness/材料厚度: 2.0x2.0x2.0mm
 Capacity/承重: 80kg(450mm标准长度/as standard)

Cycle/开合: 50000times 5万次
 Salt Spray Test/盐雾试验: 48H
 Finish/表面处理: Zinc 镀锌
 Installation/安装方法: side mount 侧面安装

Thickness Range/材料厚度:
 ① 2.0mm
 ② 2.0mm
 ③ 2.0mm

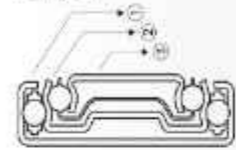

带锁把手
Lock handle



可拆卸扣
Removable stop

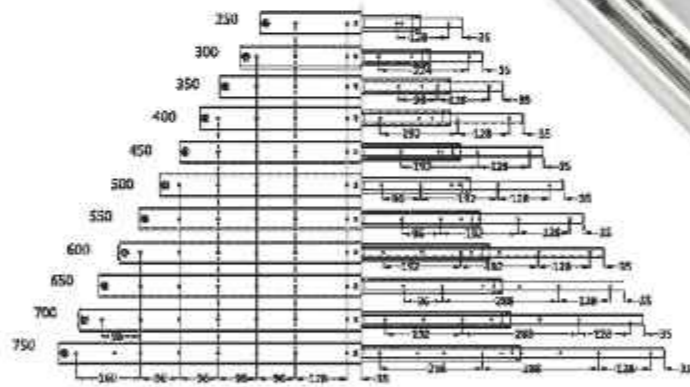

SIZE	系列长度 Series length	抽屉长度 Drawer length	最小柜深 Minimum cabinet depth
10寸 10Inch	250mm	250mm	254mm
12寸 12Inch	300mm	300mm	304mm
14寸 14Inch	350mm	350mm	354mm
16寸 16Inch	400mm	400mm	404mm
18寸 18Inch	450mm	450mm	454mm
20寸 20Inch	500mm	500mm	504mm
22寸 22Inch	550mm	550mm	554mm
24寸 24Inch	600mm	600mm	604mm
26寸 26Inch	650mm	650mm	654mm
28寸 28Inch	700mm	700mm	704mm
30寸 30Inch	750mm	750mm	754mm

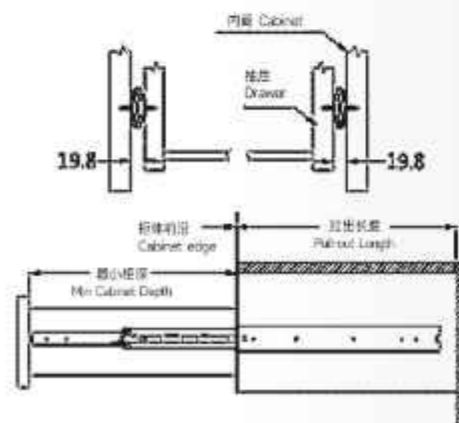

滑轨系列

2-Fold Soft Close Slim Tandem Box / 二节缓冲超薄骑马抽

Material/材质: Cold rolled steel 冷轧钢
 Length/长度: 20inch(500mm)
 Load capacity/额定负重: 35kg
 Installation/安装方式: Under mount 底部安装

Cycle/开合: 50000times 5万次
 Salt Spray Test/盐雾试验: 48H
 Finish/表面处理: Grey/灰色



3D把手
3D handle



精密组尼器
Precision setting pin



镀锌板, 耐腐蚀
Galvanized, corrosion-resistant

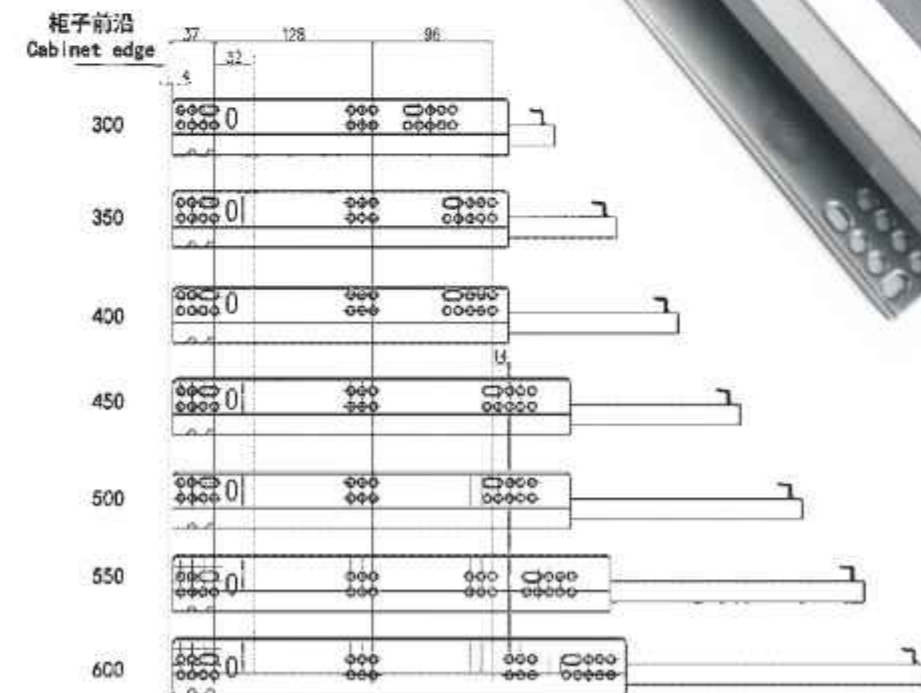

3-Fold Soft Close Slim Tandem Box / 三节缓冲超薄骑马抽

Material/材质: Cold rolled steel 冷轧钢
 Length/长度: 20inch(500mm)
 Load capacity/额定负重: 35kg
 Installation/安装方式: Under mount 底部安装

Cycle/开合: 50000times 5万次
 Salt Spray Test/盐雾试验: 48H
 Finish/表面处理: Grey/灰色



3D把手
3D handle



精密阻尼器
Precision damping roller



镀锌板, 耐腐蚀
Galvanized, corrosion resistant

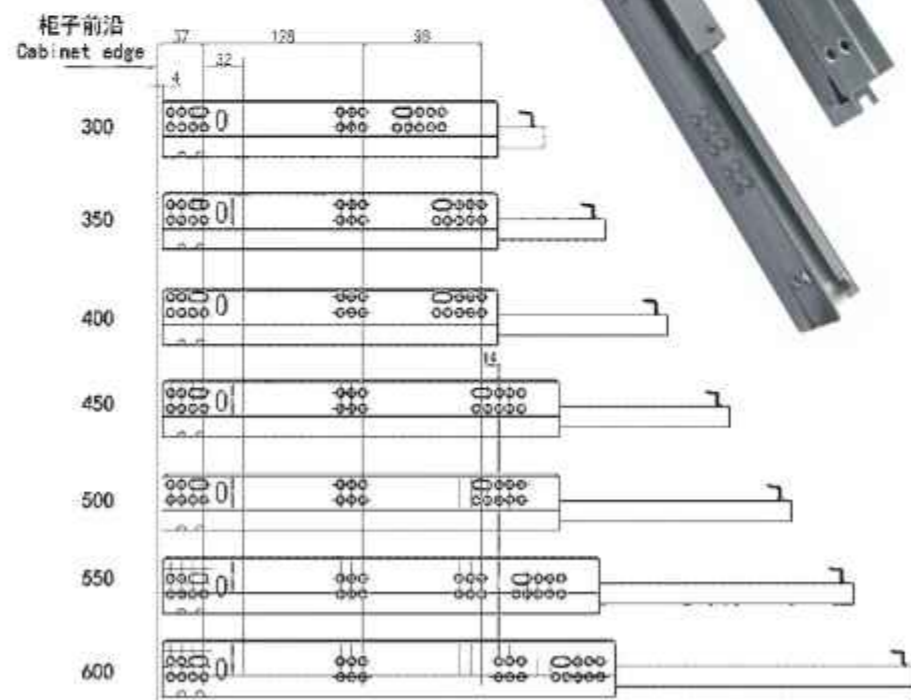

Gas Spring



气撑也称为气弹簧或支撑杆，是一种用于橱柜五金配件的装置，具有支撑、缓冲、制动以及角度调节等功能。它是采用液压油封设计的，经久耐用，简直是厨房里的万能工具。

Air support, also known as gas spring or support rod, is a device used for cabinet hardware accessories with functions such as support, buffering, braking, and angle adjustment. It is designed with hydraulic oil seals, which are durable and can be used as a universal tool in the kitchen.



Gas Spring 技术参数

SUPPORT BEARING CAPACITY-支撑承载力说明图

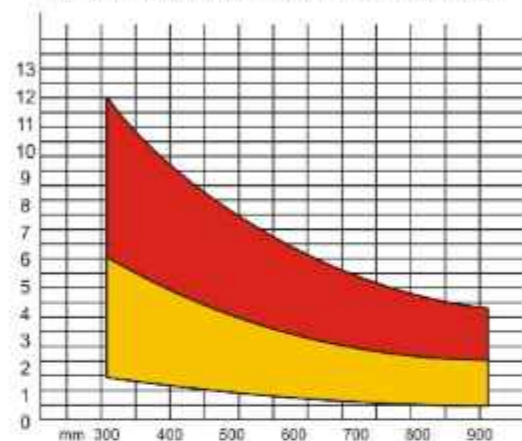

使用 1 只 Use 1 piece
使用 2 只 Use 2 pieces

管径: 15x1.00mm
Pipe diameter: 15x1.00mm
杆直径: Φ=6mm
Rod diameter: Φ=6mm

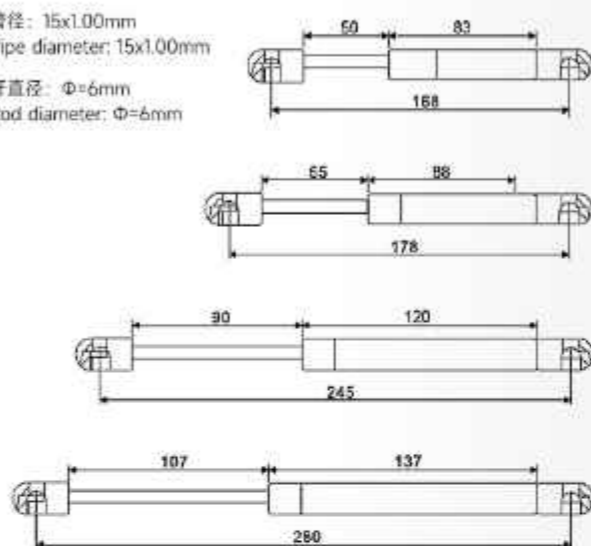

产品尺寸 Product size	管长 Pipe length(mm)	行程 Stroke(mm)	中心距 Center distance(mm)
6"	83	50	168
8"	88	55	178
10"	120	90	245
12"	137	107	280

LIFTING FORCE SELECTION REFERENCETABLE-举力选择参照表

开门角度 Open angle	80°				90°				100°			
	300	400	500	600	300	400	400	600	300	400	500	600
80N	≤ 2.6	≤ 2.2	≤ 1.7	≤ 1.3	≤ 2.4	≤ 2.0	≤ 1.6	≤ 1.2	≤ 2.1	≤ 1.7	≤ 1.4	≤ 1.0
100N	≤ 3.3	≤ 2.7	≤ 2.2	≤ 1.6	≤ 3.0	≤ 2.5	≤ 2.0	≤ 1.5	≤ 2.6	≤ 2.2	≤ 1.7	≤ 1.3
120N	≤ 4	≤ 3.3	≤ 2.6	≤ 2.0	≤ 3.6	≤ 3.0	≤ 2.4	≤ 1.8	≤ 3.2	≤ 2.6	≤ 2.1	≤ 1.6

注: 请按此表格选择合适的型号及门的重量, 达到最佳效果。
Note: Please select the appropriate model and door weight according to this table to achieve the best results.

气动支撑系列



GC-01

主要材质: 铁, 塑料, 铜
Main material: iron/plastic/copper

颜色: 银色/黑色/白色
Color: Silver/Black/White

适用范围: 橱柜的木门/铝框门
Scope of application: Cabinet wooden doors/aluminum frame doors

处理工艺: 电镀, 喷漆
Treatment process: electroplating, spray painting

长度: 6" 8" 10" 12"
Length: 6" 8" 10" 12"

支撑力: 50N, 60N, 80N, 100N, 120N, 150N, 180N, 200N, 250N
Force: 50N, 60N, 80N, 100N, 120N, 150N, 180N, 200N, 250N

可根据客户需求定制: 气动向上支撑、液压向下支撑、任意角度支撑
Can be customized according to customer needs: pneumatic upward support, hydraulic downward support, support at any angle

安装示例:
Installation example:

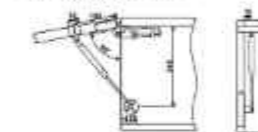

上翻 Up Lifting

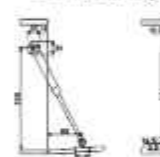

下翻 Down Lifting



配件清单
Accessories list:



GC-02

主要材质: 铁, 塑料, 铜
Main material: iron/plastic/copper

颜色: 银色/黑色/白色
Color: Silver/Black/White

适用范围: 橱柜的木门/铝框门
Scope of application: Cabinet wooden doors/aluminum frame doors

处理工艺: 电镀, 喷漆
Treatment process: electroplating, spray painting

长度: 6" 8" 10" 12"
Length: 6" 8" 10" 12"

支撑力: 50N, 60N, 80N, 100N, 120N, 150N, 180N, 200N, 250N
Force: 50N, 60N, 80N, 100N, 120N, 150N, 180N, 200N, 250N

可根据客户需求定制: 气动向上支撑、液压向下支撑、任意角度支撑
Can be customized according to customer needs: pneumatic upward support, hydraulic downward support, support at any angle

安装示例:
Installation example:

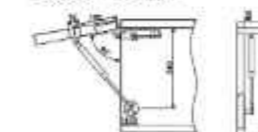

上翻 Up Lifting



下翻 Down Lifting



配件清单
Accessories list:



Gas Spring



GC-03

主要材质: 铁, 塑料, 铜
Main material: iron, plastic, copper

颜色: 银色/黑色/白色
Color: Silver/Black/White

适用范围: 橱柜的木门/铝框门
Scope of application: Cabinet wooden doors/aluminum frame doors

处理工艺: 电镀, 喷漆
Treatment process: electroplating, spray painting

长度: 6" 8" 10" 12"
Length: 6" 8" 10" 12"

支撑力: 50N, 60N, 80N, 100N, 120N, 150N, 180N, 200N, 250N
Force: 50N, 60N, 80N, 100N, 120N, 150N, 180N, 200N, 250N

可根据客户需求定制: 气动向上支撑、液压向下支撑、任意角度支撑
Can be customized according to customer needs: pneumatic upward support, hydraulic downward support, support at any angle

安装示例:
Installation example:

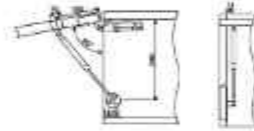

上翻 Up Lifting

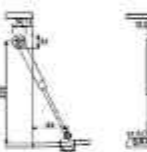

下翻 Down Lifting



配件清单
Accessories list:



气动支撑系列



GC-05

主要材质: 铁, 塑料, 铜
Main material: iron, plastic, copper

颜色: 银色/黑色/白色
Color: Silver/Black/White

适用范围: 橱柜的木门/铝框门
Scope of application: Cabinet wooden doors/aluminum frame doors

处理工艺: 电镀, 喷漆
Treatment process: electroplating, spray painting

长度: 6" 8" 10" 12"
Length: 6" 8" 10" 12"

支撑力: 50N, 60N, 80N, 100N, 120N, 150N, 180N, 200N, 250N
Force: 50N, 60N, 80N, 100N, 120N, 150N, 180N, 200N, 250N

可根据客户需求定制: 气动向上支撑、液压向下支撑、任意角度支撑
Can be customized according to customer needs: pneumatic upward support, hydraulic downward support, support at any angle

安装示例:
Installation example:

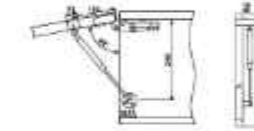

上翻 Up Lifting

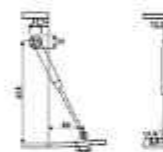

下翻 Down Lifting



配件清单
Accessories list:



GC-04

主要材质: 铁, 塑料, 铜
Main material: iron, plastic, copper

颜色: 银色/黑色/白色
Color: Silver/Black/White

适用范围: 橱柜的木门/铝框门
Scope of application: Cabinet wooden doors/aluminum frame doors

处理工艺: 电镀, 喷漆
Treatment process: electroplating, spray painting

长度: 6" 8" 10" 12"
Length: 6" 8" 10" 12"

支撑力: 50N, 60N, 80N, 100N, 120N, 150N, 180N, 200N, 250N
Force: 50N, 60N, 80N, 100N, 120N, 150N, 180N, 200N, 250N

可根据客户需求定制: 气动向上支撑、液压向下支撑、任意角度支撑
Can be customized according to customer needs: pneumatic upward support, hydraulic downward support, support at any angle

安装示例:
Installation example:



上翻 Up Lifting

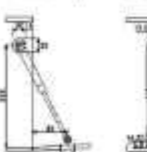

下翻 Down Lifting



配件清单
Accessories list:



GC-06

主要材质: 铁, 塑料, 铜
Main material: iron, plastic, copper

颜色: 银色/黑色/白色
Color: Silver/Black/White

适用范围: 橱柜的木门/铝框门
Scope of application: Cabinet wooden doors/aluminum frame doors

处理工艺: 电镀, 喷漆
Treatment process: electroplating, spray painting

长度: 6" 8" 10" 12"
Length: 6" 8" 10" 12"

支撑力: 50N, 60N, 80N, 100N, 120N, 150N, 180N, 200N, 250N
Force: 50N, 60N, 80N, 100N, 120N, 150N, 180N, 200N, 250N

可根据客户需求定制: 气动向上支撑、液压向下支撑、任意角度支撑
Can be customized according to customer needs: pneumatic upward support, hydraulic downward support, support at any angle

安装示例:
Installation example:

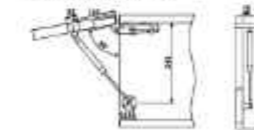

上翻 Up Lifting



下翻 Down Lifting



配件清单
Accessories list:

